



The  
**Craftsman**  
COLLECTION  
Quality Handcrafted in Pennsylvania, USA



**F**or more than 28 years we have been designing and building furniture for the Craftsman Collection brand. Currently we employ the fourth generation of family woodworkers.

Every piece of furniture is produced with sustainably harvested American hardwoods which means that every tree that is cut down has a replacement sapling that is growing, sequestering carbon, and releasing oxygen. Instead of deforesting, our lumbermen are pruning and refining our wonderful resource, the forest.

During the last 15 years we have added a large variety of motion and upholstered furniture. Today we are happy to say that 100% of our steel mechanisms are designed and manufactured in America. The foam cushions are made in North Carolina and then carefully upholstered in our own shops by highly skilled seamstresses and upholsterers.

For maximum control of quality our furniture is stained and coated with a conversion varnish in our own finishing facility. The finish products have been tested extensively and we are confident that they will preserve the wooden surface of your furniture for years.

With passion for good furniture and skilled craftsmen we feel confident that your furniture is built to last. That's the reason we offer our industry leading warranties.





# GENERAL WARRANTY AND CARE

**T**he Craftsman Collection warrants to you, the original retail purchaser, ten year protection against manufacturing defects of any wooden components. Defective parts will be repaired or replaced at our discretion.

**W**ood is a natural product, and although we take great care to match grain and colors, some variation may occur.

**W**ith some care your furniture will last for years! Keeping it dust free is very important. Use a soft towel dampened with water or a quality furniture polish to remove the dust. Do not use a silicone based furniture polish!

**N**atural wood will expand and contract with the seasons. This is normal, but it is important to avoid extremes in humidity and temperatures. Avoid having furniture in direct sunlight, close to heat sources, or in extremely damp or dry environments.

**A**ll warranties are void if the recommended care displayed above was not exercised.

## UPHOLSTERY WARRANTY

**Springs and Recliner Mechanisms:** The Craftsman Collection warrants to you, the original retail purchaser, ten year protection against manufacturing defects of the springs and recliner mechanisms. Electrical components of power recliners carry a two year warranty.

**Glider Bearings:** (250 lb. load rating) The Craftsman Collection warrants to you, the original retail purchaser, a three year warranty. If found to be defective, we will replace the defective bearing or bearings.

**Seat and Back Cushions:** The Craftsman Collection warrants to you, the original retail purchaser, ten year protection against manufacturing defects of seat and back cushions. Cushion warranty is for loss of cushion resiliency and not normal flattening and softening of cushions, which is a result of regular use and aging and should not be considered a manufacturing defect. If found defective, cushions will be replaced free of charge. After 2 years we will not be liable for freight.

Cushion softness is significantly affected by the type of fabric or leather that surrounds it. Where applicable, a rotation of the cushion will greatly extend the life of both the cushion and fabric.

**Fabric:** We offer a one year warranty against unusual wear of fabric under normal use and with proper care. This warranty does not cover fading, pilling, or crushing of fibers which can occur with the normal use of some fabrics. All claims within warranty will be submitted for industry testing. We will tender warranty only if it is determined to be an actual fabric defect.

**Genuine Leather:** We offer a three year warranty against unusual wear of leather under normal use and proper care. Genuine leather may be one of the most durable upholstery materials; however, even the best quality leather has flaws and natural markings. Our leather is a protected aniline dyed, top grain leather, making for easy cleanup. (A soft damp cloth is recommended.) However, body oils and dust, etc., will cause this leather to develop a natural patina as it is used, especially in light colored leathers. Slight variations of color, along with the above traits, are characteristic of genuine leathers and distinguish them from synthetic materials. If uniform color and consistent grain are required, a faux leather (vinyl) may be a better choice.

Any of the above warranties are void if it is determined that the furniture was abused, used by pets, or heavily soiled.



# M

As the Spanish swept across the southwest corner of North America they built furniture out of necessity. Today their simple style still resonates with seekers of simplicity and functional beauty. The sturdy lines of this revival style paired with the finest of American hardwoods complements the craftsmanship and comfort of Craftsman Collection Mission.

## MISSION OPTIONS

- Quarter-Sawn White Oak
- Brown Maple
- Red Oak
- Cherry
  
- Fabric
- Faux Leathers
- Genuine Leather

## MISSION FEATURES

- Handmade in America
- Durable Cushions
- Dovetail Drawer Boxes
- Full Extension Drawer Slides

and  
comfort  
of course!





# MISSION





# COFFEE TABLES & SOFA SERVERS

all pieces shown in oak with harvest stain



#01  
JR. COFFEE TABLE  
42" w x 18" d x 19" h

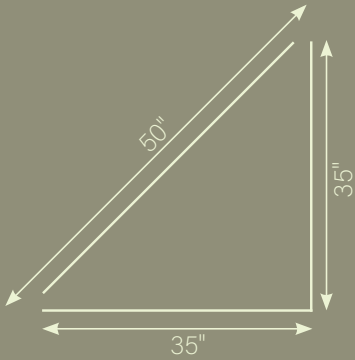

#12  
CORNER COFFEE TABLE  
19" high



#04  
SQUARE COFFEE TABLE  
34" w x 34" d x 19" h



#03  
COFFEE TABLE WITH DRAWER  
50" w x 24" d x 19" h





#13  
**LIFT TOP COFFEE TABLE**  
50"w x 24"d x 19"h



Shown in raised position (29").  
Features smooth acting lift mechanism  
made in the USA.



#79  
**SOFA SERVER**  
14"w x 16"d x 24"h



#77  
**LARGE SOFA SERVER**  
20"w x 16"d x 27"h

# MISSION



# MISSION END TABLES

all pieces shown in oak with harvest stain



#02  
JR. END TABLE  
22" w x 16" d x 25" h



#48  
ROUND END TABLE  
22" x 22" h

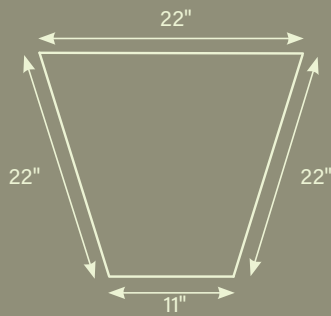

#11  
WEDGE TABLE  
22" w x 22" d x 25" h



#72  
END TABLE  
20" w x 23" d x 25" h



#06  
CHAIR-SIDE TABLE  
16" w x 22" d x 25" h





#07  
END TABLE WITH DRAWER  
24" w x 24" d x 25" h



#05  
SQUARE END TABLE  
24" w x 24" d x 25" h



# MISSION



# SOFA TABLES & HALL FURNITURE

all pieces shown in oak with harvest stain

#98  
2 DRAWER SOFA TABLE  
50" w x 16" d x 30" h



#70  
HALL TABLE  
27" w x 14" d x 30" h



#99  
SOFA TABLE  
64" w x 16" d x 30" h





#20  
**STORAGE BENCH**  
42"w x 11"d x 19"h



#32  
**DEACON'S BENCH WITH STORAGE**  
47"w x 22"d x 45"h



#78  
**CLOTHES TREE**  
16"w x 16"d x 68"h

# MISSION

# ENTERTAINMENT

all pieces shown in oak with harvest stain



#90  
**TV/VCR CABINET**  
35" w x 19" d x 30" h  
with adjustable shelves



#91  
**ENTERTAINMENT CENTER**  
50" w x 19" d x 30" h



#93  
**ENTERTAINMENT CENTER**  
50" w x 19" d x 30" h  
with adjustable shelves





#68  
**FUTON**  
 86" w x 37" d x 38" h



Back View



**FUTON IN BED POSITION**  
 86" w x 54" d x 25" h

**MATTRESS OPTIONS**

Our futon mattresses are 9" thick and constructed of high quality foam and cotton. The mattress comes with a standard sage micro-fiber cover but is available in any of the colors below. The mattress can also be fitted with a fabric cover as seen in the pictures above. See page 57 for more fabric options

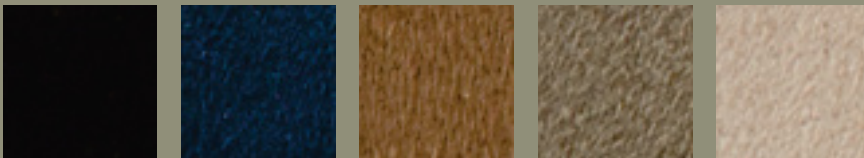

black

blue

chocolate

sage

tan

# MISSION





#85  
**MISSION LOVESEAT**  
60"w x 35"d x 37"h\*



#87  
**OTTOMAN**  
23"w x 16"d x 15"h



#86  
**SOFA**  
86"w x 35"d x 37"h\*  
shown in 10-11 Myth fabric

\* all seats are approximately 19" high and 20" deep





Back View



#84  
**MORRIS CHAIR**  
34"w x 35"d x 37"h\*  
shown in 10-11 Myth fabric

Morris chairs feature an 8 position recline.



Based on a design found in a small cabinetry shop in Sussex, England, the Morris Chair was developed and first sold by Morris and Company around 1866. Through the influence of Gustav Stickley and the American Arts and Crafts movement, the American Morris chair took on an unsophisticated air of sturdy reliability.

Our rendition of this faithful old chair features an eight position recline, gently curved armrests, and the same legacy of durable comfort.

# MISSION





#62  
**RECLINER LOVESEAT**

58" w x 35" d x 42" h\*  
shown in 16-52 Reap fabric



#63  
**RECLINER SOFA**  
82" w x 35" d x 42" h\*  
shown in 16-52 Reap fabric

\* all seats are approximately 19" high and 20" deep





Wired/Wireless Powered Recline Controls



#61  
**RECLINER**  
34"w x 35"d x 42"h\*  
shown in whiskey leather

Bustle Back Upgrade



From the legs to the last detail of the upholstery we take extra pleasure in creating exceptional recliners. The easy push-back mechanism is made in America and is built to handle all the wear that a comfortable recliner is prone to get. Each section of the loveseat and sofa recliners reclines independently.

Powered recliner upgrades come with a standard corded control that can be exchanged for cordless remote controls.

The Bustle Back upgrade option gives the recliner a soft cushion feel without losing its beauty.

# MISSION





#55  
**ROCKER**  
29" w x 36" d x 41" h\*



#53  
**SWIVEL GLIDER**  
31" w x 32" d x 42" h\*

#54  
**GLIDER OTTOMAN**  
23" w x 16" d x 15" h



#56  
**LIBRARY CHAIR**  
29" w x 27" d x 43" h\*



#52  
**GLIDER**  
31" w x 32" d x 42" h\*

\* all seats are approximately 19" high and 20" deep





Semi-Recline Position

#65  
**SWIVEL GLIDER RECLINER**  
31" w x 35" d x 41" h\*  
shown in cobblestone leather



Bustle Back Upgrade

We're serious about comfort. If you don't believe it try our swivel recliner. The mechanism is made right here in the United States. Paired with American hardwoods and premium upholstery that will resist the wear of everyday use.

Add the bustle back upgrade for the next level of comfort!

# MISSION

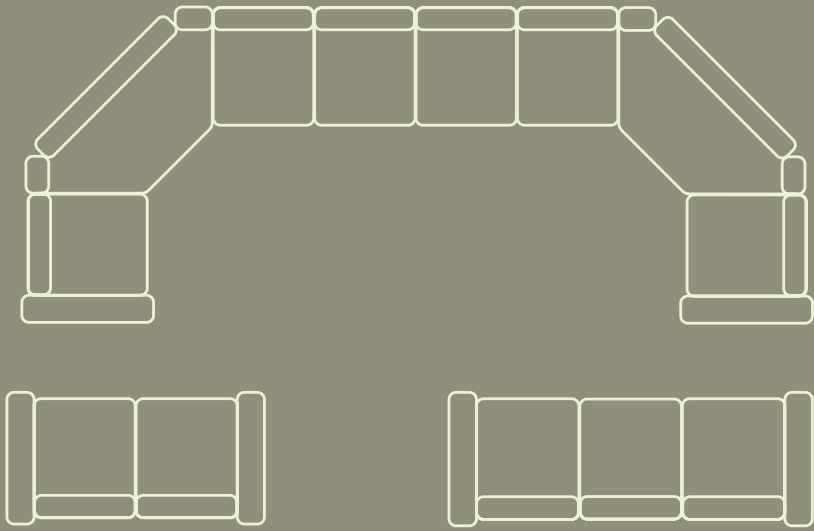

What will you create?

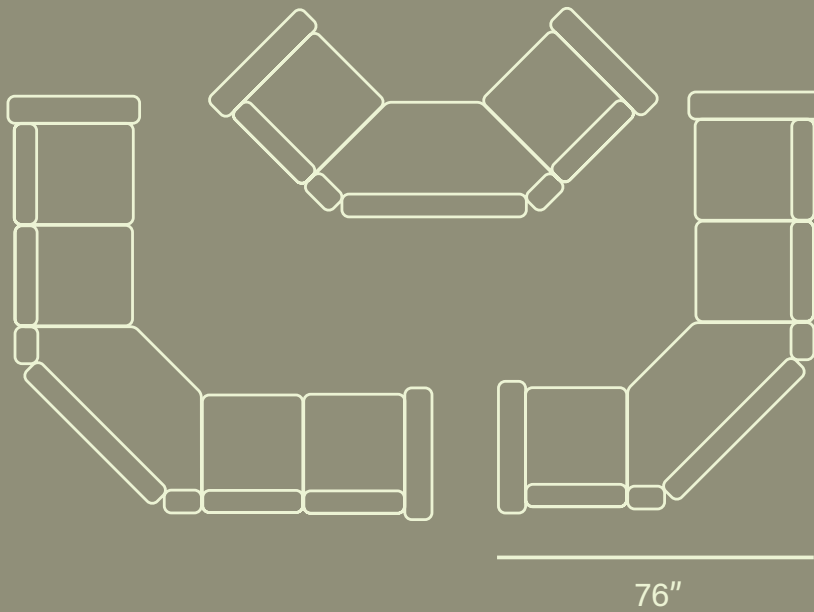

#16  
RIGHT ARM UNIT

right and left arm units are sold as a set

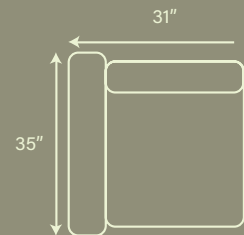

# Vari-LOC

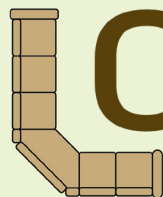

Sectional Seating

The Vari-Loc sectional seating allows you to create multiple configurations from four simple base units. Each unit locks securely to the next to form a solid and seamless sectional sofa. And when it's time to move, your sectional will easily disassemble into manageable pieces.





#17  
MODULAR UNIT

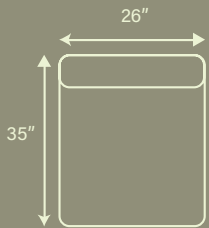

#15  
CORNER UNIT

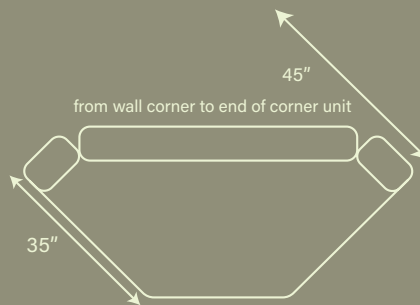

#16  
LEFT ARM UNIT  
right and left arm units are sold as a set

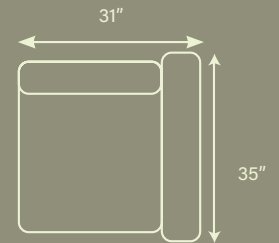

# MISSION



#58  
**16" THROW PILLOW**  
available in leather and fabric



#59  
**20" THROW PILLOW**  
available in leather and fabric



#81  
**CLUB LOVESEAT**  
57" w x 35" d x 30" h\*  
shown in Oak with  
Autumn Wheat stain



#80  
**CLUB SOFA**  
78" w x 35" d x 30" h\*

\* all seats are approximately 19" high and 20" deep





#82  
**CLUB CHAIR**  
36" w x 35" d x 30" h\*  
shown in Quarter-sawn White Oak  
with Michaels OCS 113 stain

Back View



This heritage take on the sofa is heavily rooted in mission style. The low profile makes the club a great option when you want to maintain an open feel or when placing it in front of a window. All fabric seat and back cushions come in one unit, as seen on the loveseat, unless special ordered. Leather cushions will be divided, two sections for loveseats, three sections for sofas.

# MISSION



# Santa Fe

With their clean, open silhouettes the Santa Fe occasionals portray an exceptionally pure mission and pair well with our Classic Mission and Panel Mission upholstery.



#873  
**SANTA FE COFFEE TABLE**  
 41" w x 19" d x 19" h\*



#877  
**SANTA FE SOFA TABLE**  
 42" w x 16" d x 30" h\*



#876  
**SANTA FE END TABLE**  
 18" w x 22" d x 22" h\*





#36  
**FIREPLACE**  
59" w x 14" d x 42" h\*  
with electric fireplace insert



Side View

Bring the comfortable glow of a fireplace into any room of your house without the need to vent or make permanent changes. The fireplace insert can be connected to a 110 volt wall outlet and provides electric heat and flame simulations all controlled with the handheld remote. The fireplace sides open to reveal a hidden bookshelf.

# MISSION

# CLASSIC M

The petite spindles of the mission style give way to the wide slats, thick tops, and heavy legs of the Classic Mission style. The durable simplicity that's written all over this style promise a stable, comforting atmosphere.

## CLASSIC MISSION OPTIONS

- Quarter-Sawn White Oak
- Brown Maple
- Red Oak
- Cherry
  
- Fabric
- Faux Leathers
- Genuine Leather

## CLASSIC MISSION FEATURES

- Handmade in America
- 1" Thick Table Tops
- Durable Cushions
- Dovetail Drawer Boxes
- Full Extension Drawer Slides

and  
*comfort*  
of course!





# MISSION







#176  
**CLASSIC END TABLE**  
21"w x 25"d x 25"h

**MORE IN CLASSIC MISSION**  
Many of the items featured in pages 13 to 23 of this catalog are also available in classic mission. Here's just a few of them:

- 168 Futon
- 116 Sectional
- 182 Club Chair
- 181 Club Loveseat
- 180 Club Sofa
- 165 Swivel Recliner
- 154 Gliding Ottoman

#173  
**COFFEE TABLE**  
50"w x 25"d x 19"h



#177  
**SOFA TABLE**  
50"w x 16"d x 30"h





#155  
**ROCKER**  
29"w x 36"d x 41"h\*



#156  
**LIBRARY CHAIR**  
29"w x 27"d x 43"h\*



# CLASSIC MISSION

\* all seats are approximately 19" high and 20" deep





#161  
**RECLINER**  
34" w x 35" d x 42" h\*



#162  
**RECLINER LOVESEAT**  
58" w x 35" d x 42" h\*



#163  
**RECLINER SOFA**  
82" w x 35" d x 42" h\*



#153  
**SWIVEL GLIDER**  
31" w x 32" d x 42" h\*



#184  
**MORRIS CHAIR**  
34"w x 35"d x 37"h\*



#187  
**OTTOMAN**  
23"w x 16"d x 15"h\*



#185  
**LOVESEAT**  
60"w x 35"d x 37"h\*

#186  
**SOFA**  
86"w x 35"d x 37"h\*



See pages 13 to 23 for details on  
our upholstered items.

\* all seats are approximately 19" high and 20" deep

# CLASSIC MISSION

# PANEL MISSION

Elegant with a slightly aristocratic air Panel Mission is a refined mission style that displays the finest in American craftsmanship. The rail & stile side panel is a technique that the early masters, though they may not have used it, would surely have been proud of.

## PANEL MISSION OPTIONS

- Quarter-Sawn White Oak
- Brown Maple
- Red Oak
- Cherry
  
- Fabric
- Faux Leathers
- Genuine Leather

## PANEL MISSION FEATURES

- Handmade in America
- Rail & Stile Panels
- Durable Cushions
- Dovetail Drawer Boxes
- Full Extension Drawer Slides

and  
*comfort*  
of course!





# MISSION







#261  
**RECLINER**  
34" w x 35" d x 42" h\*



#287  
**OTTOMAN**  
23" w x 16" d x 15" h

#284  
**MORRIS CHAIR**  
34" w x 35" d x 37" h\*



#263  
**RECLINER SOFA**  
82" w x 35" d x 42" h\*

See pages 13 to 23 for details on  
our upholstered items.

\* all seats are approximately 19" high and 20" deep





#276  
END TABLE  
21"w x 25"d x 25"h



#226  
STORAGE OTTOMAN  
36"w x 20"d x 18"h



# PANEL MISSION



**MORE IN PANEL MISSION**

Many of the items featured in pages 13 to 23 of this catalog are also available in panel mission. Here's just a few of them:

- 268 Futon
- 216 Sectional
- 261 Recliner
- 265 Swivel Recliner
- 254 Gliding Ottoman
- 256 Library Chair



#253  
**SWIVEL GLIDER**  
31"w x 32"d x 42"h\*



#285  
**LOVESEAT**  
60"w x 35"d x 37"h\*



#280  
**CLUB SOFA**  
78"w x 35"d x 30"h\*

\* all seats are approximately 19" high and 20" deep





#255  
**ROCKER**  
29"w x 36"d x 41"h\*

Back View of Club Sofa



PANEL  
MISSION



First designed by a religious sect nicknamed the Shakers this style has a petite feel thanks to the signature tapering of the legs. Like the Spanish before them the Shakers embraced simplicity and utility, values that we work hard to build into our Shaker style.

S

## SHAKER OPTIONS

- Quarter-Sawn White Oak
- Brown Maple
- Red Oak
- Cherry
  
- Fabric
- Faux Leathers
- Genuine Leather

## SHAKER FEATURES

- Handmade in America
- Rail & Stile Panels
- Durable Cushions
- Dovetail Drawer Boxes
- Full Extension Drawer Slides



and  
comfort  
of course!



h a k e r







#573  
COFFEE TABLE WITH DRAWER  
42" w x 18" d x 19" h



#513  
COFFEE TABLE WITH LIFT TOP  
44" w x 22" d x 19" h (29" raised)



#509  
PETITE SOFA TABLE  
38" w x 12" d x 30" h



#501  
PETITE COFFEE TABLE  
38" w x 16" d x 17" h



#577  
SOFA TABLE WITH DRAWER  
42" w x 14" d x 30" h



#578  
WRITING DESK  
48" w x 22" d x 30" h





#576  
END TABLE WITH DRAWER  
18"w x 24"d x 25"h



#502  
PETITE END TABLE  
16"w x 22"d x 22"h



shaker



**MORE IN SHAKER**

Many of the items featured in pages 13 to 23 of this catalog are also available in Shaker. Here's just a few of them:

- 568 Futon
- 516 Sectional
- 561 Recliner
- 563 Recliner Sofa
- 565 Swivel Recliner
- 554 Gliding Ottoman
- 556 Library Chair



#587  
**OTTOMAN**  
23"w x 16"d x 15"h

#584  
**MORRIS CHAIR**  
32"w x 35"d x 37"h\*



#562  
**RECLINER LOVESEAT**  
56"w x 35"d x 42"h\*

\* all seats are approximately 19" high and 20" deep





#555  
**ROCKER**  
29"w x 36"d x 41"h\*



#553  
**SWIVEL GLIDER**  
31"w x 32"d x 42"h\*



shaker



# rustic CO

The lake, fields, and forest come alive in this classic farmhouse style. Early American architecture is visible in the details that speak of a time where long winter days were spent buried in the farm shop slowly and carefully perfecting another family heirloom.

## RUSTIC COUNTRY OPTIONS

- Brown Maple
- Red Oak
- Cherry
  
- Fabric
- Faux Leathers
- Genuine Leather

## RUSTIC COUNTRY FEATURES

- Handmade in America
- Durable Cushions
- Dovetail Drawer Boxes
- Full Extension Drawer Slides
- Straight or Bunt Foot Options

and  
comfort  
of course!





# Country







#677  
**SOFA TABLE**  
50"w x 16"d x 30"h

**MORE IN RUSTIC COUNTRY**  
The items below are also available in Rustic Country. You can find more information about these items on pages 13 to 23.

- 662 Recliner Loveseat
- 662 Recliner Sofa
- 685 Loveseat
- 686 Sofa



#673  
**COFFEE TABLE**  
50"w x 25"d x 19"h



#661  
**RECLINER**  
34"w x 35"d x 42"h  
shown with straight legs





#676  
**END TABLE**  
21" w x 25" d x 25" h



Bunt Foot

Straight Foot



#687  
**OTTOMAN**  
23" w x 16" d x 15" h

#684  
**MORRIS CHAIR**  
32" w x 35" d x 37" h\*

rustic  
**country**



Sea vibes come naturally with this nautical mission style. It's as if the Spanish sea captains asked for their own twist to Spanish Revival mission. Right at home in your oceanfront cottage but an equally excellent way to bring a bit of the seashore right into your home. The sea is calling, who can resist...

## MISSION OPTIONS

- Brown Maple
- Red Oak
- Cherry
  
- Fabric
- Faux Leathers
- Genuine Leather

## MISSION FEATURES

- Handmade in America
- Durable Cushions
- Dovetail Drawer Boxes
- Full Extension Drawer Slides
- Flared Feet and Gentle Curves

and  
comfort  
of course!





# Breezy

- Point -







#777  
SOFA TABLE  
42" w x 15" d x 30" h



#713  
COFFEE TABLE WITH LIFT TOP  
44" w x 22" d x 19" h (29" raised)



#773  
COFFEE TABLE  
42" w x 19" d x 19" h\*





#772  
END TABLE  
19" w x 22" d x 23" h



#776  
END TABLE  
18" w x 22" d x 23" h



Breezy  
- Point -



**MORE IN BREEZY POINT**

Many of the items featured in pages 13 to 23 of this catalog are also available in Breezy Point.

Here's just a few of them:

- 761 Recliner
- 762 Recliner Loveseat
- 765 Swivel Recliner
- 753 Swivel Glider
- 754 Gliding Ottoman
- 716 Sectional



#787  
**OTTOMAN**  
23"w x 16"d x 15"h

#784  
**MORRIS CHAIR**  
34"w x 35"d x 37"h\*



#763  
**RECLINER SOFA**  
82"w x 35"d x 42"h\*





#786  
SOFA  
85"w x 35"d x 37"h\*



#785  
LOVESEAT  
56"w x 35"d x 37"h\*

*Breezy*  
- Point -



# Wood Species

Every piece of furniture is produced with sustainably harvested American hardwoods which means that every tree that is cut down has a replacement sapling that is growing, sequestering carbon, and releasing oxygen. Instead of deforesting, our lumbermen are pruning and refining our wonderful resource, the forest.

**R**ed Oak is a hardwood prized for its hardness. The grain pattern is large and often stains darker showing the character of the oak and making each item a unique masterpiece.

**M**aple has a tight grain pattern and finishes with a smooth, hard surface. It is the ideal choice when pairing with paints or gray based stains.

**C**herry's rich tones give a full bodied look to reddish stains. The grain pattern is similar to maple. Cherry stains often appear deeper and richer as they age.

**Q**uarter-Sawn White Oak can be identified by its unique ray flake grain. To create quarter-sawn wood, the log is first quartered and then cut perpendicular to the growth rings. This results in a very straight, fine-grained surface.

To make the most of that distinction, we use quad-linear posts for the legs of our upholstered mission furniture. Usually, a leg post is created from a 3"x3" board. But with that approach, only two sides of the leg display the uniqueness of the ray flake grain. To overcome this obstacle, we cut four triangular pieces from our quarter-sawn wood, then glue them together, producing a leg of incredible strength, but most importantly, a leg that displays the beauty of the ray flake grain on all four sides.



Quarter-Sawn Log

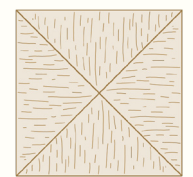

Quad-Linear Post

# DESIGN GALLERY

select colors and textures to make it truly your own



# Stains

## Oak



Natural



S-2  
OCS-101



Autumn Wheat  
421



Provincial  
OCS-112



Michaels  
OCS-113



Harvest  
OCS-116



Rich Tobacco  
OCS-228



Cappuccino  
OCS-119 #



Antique Slate  
OCS-118



Asbury  
OCS-117

## Maple



Autumn Wheat  
421



Acres  
OCS-106



Michael's  
OCS-113



Antique Slate  
OCS-118



Cappuccino  
OCS-119



Smoke  
OCS-121



Asbury  
OCS-117



Rich Tobacco  
OCS-228

## Cherry



Acres  
OCS-106



Harvest  
OCS-116



Autumn Wheat  
421



Natural



Rich Tobacco  
OCS-228

## Quarter-Sawn White Oak



Autumn Wheat  
421



Michael's  
OCS-113

### a note about colors:

Due to limitations in imaging and printing, some colors may not match exactly to what is shown here. For best results, make color choices from dealers sample blocks.



# Paint Colors

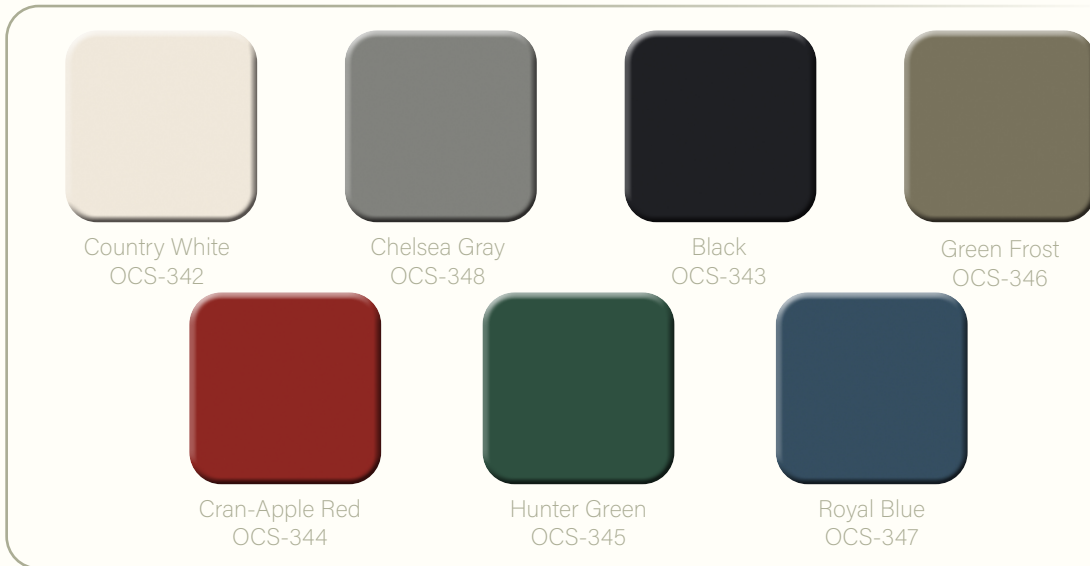

## Imagine The Possibilities!

Mix and match stain and paint colors to create your unique feel.

# Designer Finishes



### A note about colors:

Due to limitations in imaging and printing, some colors may not match exactly to what is shown here. For best results, make color choices from dealers sample blocks.



# Fabric Options

Many upholstery options are available. Ask us about our collection of 300+ choices of upholstery including Fabrics, Micro-fibers, Faux Leather and Genuine Leather by Heartland Fabrics. We also use Greenhouse Fabrics, Buckeye Fabrics, Sunbrella Fabrics, or COM (customer's own material).

## Popular Leather Choices



Pecan



Paprika



Java



Rum



Texas



Camel



London Tan



Mahogany



Grey



Mushroom



Windsor Blue



Black



Merlot



Whiskey



Oxblood

# DESIGN GALLERY

select colors and textures to make it truly your own

# Hardware

## Black



D529-A

D553-BL

D521-BL

D522-BL

D527-A

D552-BL

D550-A

K810-MB

K811-MB

standard on all Mission Collections

## Antique Brass & Oil Rubbed Bronze

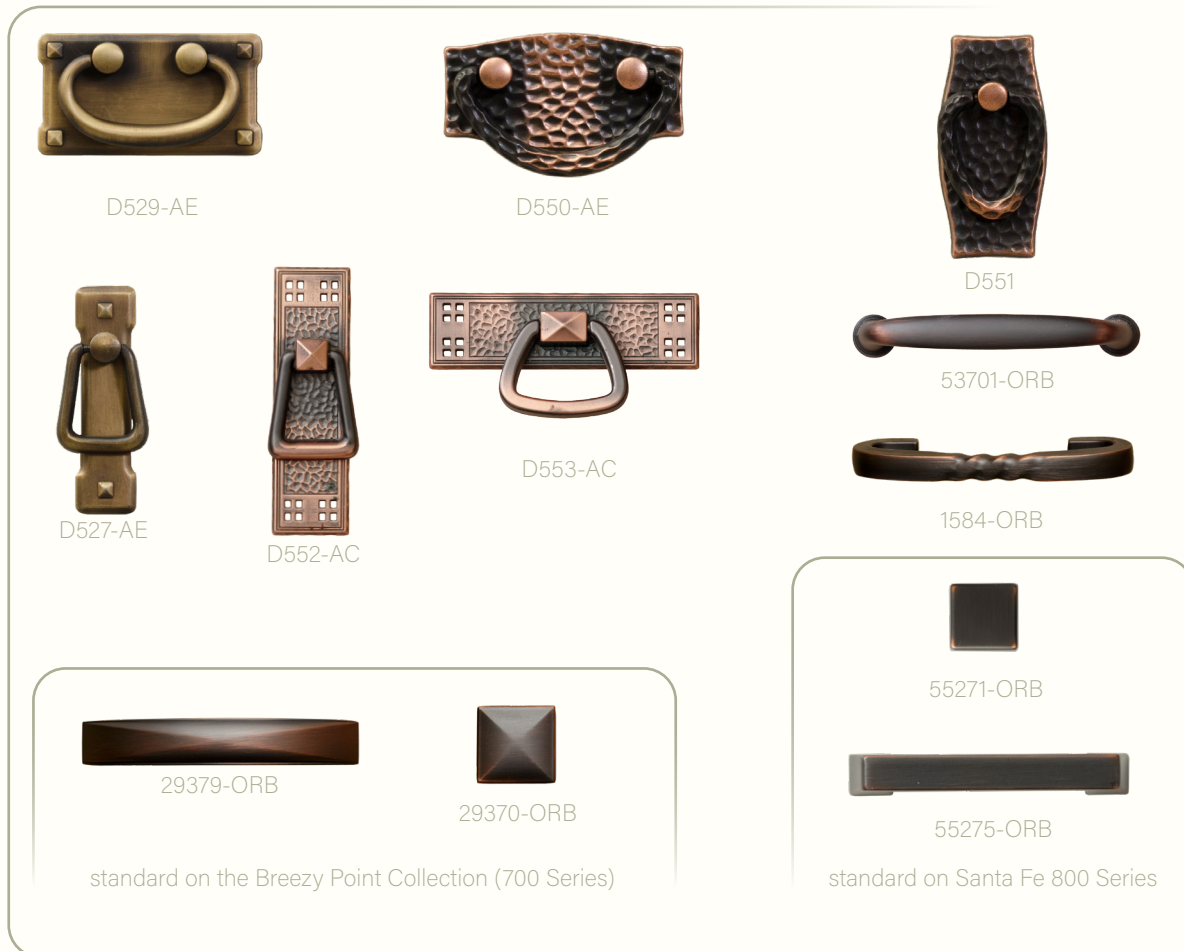

D529-AE

D550-AE

D551

D527-AE

D552-AC

D553-AC

53701-ORB

1584-ORB

29379-ORB

29370-ORB

55271-ORB

55275-ORB

standard on the Breezy Point Collection (700 Series)

standard on Santa Fe 800 Series





## Pewter & Gun Metal



D-529-B



D550-B



29379-AS



29370AS



D527-B



D551-B



K804-B



53701WN



1584-WID\*



K801-B

\*standard on the Rustic Country Collection (600 Series)

## Silver



D521-SN



K790-SN

## Wooden



K55

Standard on the Shaker Collection.  
-used for drawers and doors

# DESIGN GALLERY

select colors and textures to make it truly your own

